

Valid for Item-No.: 658170, 658175, 658190, 658195, 658170-TRI, 658175-TRI, 658190-TRI, 658195-TRI

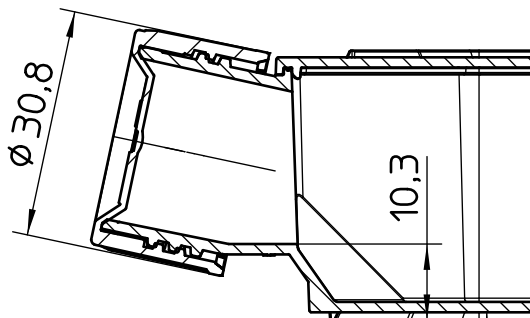

Curvature +0,6  
-0,1

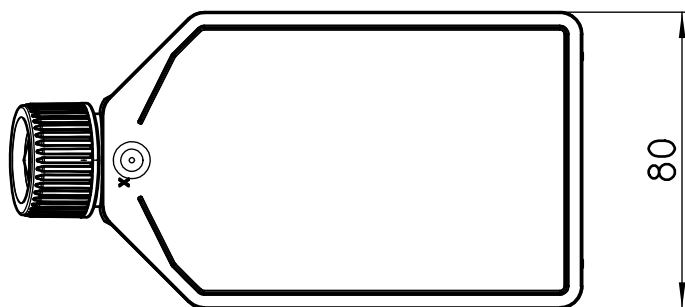
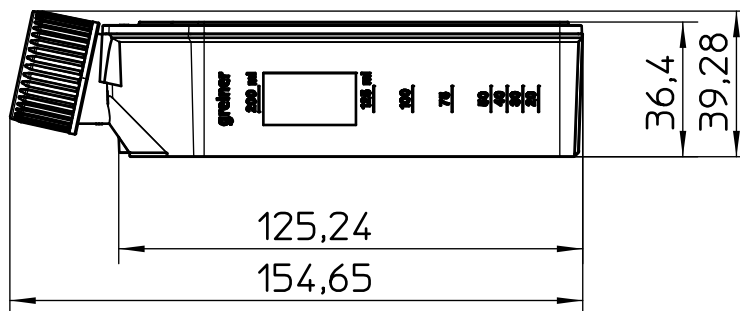

"All dimensions in mm"

Customer drawing subject to change without notice!

Uncontrolled Copy

Prior Issue	Drawn	Approved	Released	CONFIDENTIAL: Information contained in this document or drawing is confidential and proprietary to Greiner Bio-One GmbH. This document may not be reproduced for any reason without written permission from Greiner Bio-One GmbH. All rights of design, invention, and copyright are reserved.
Revision 9	Date 2011/03/04	Date 2024/07/11	Date 2024/07/11	
Date 2022/11/10	Name forb	Name kleber	Name ziegler	